

TN6728A

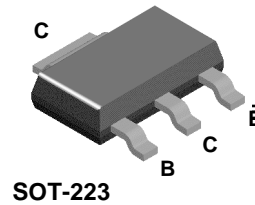

NZT6728



PNP General Purpose Amplifier

This device is designed for general purpose medium power amplifiers and switches requiring collector currents to 1.0 A. Sourced from Process 78.

Absolute Maximum Ratings*

TA = 25°C unless otherwise noted

Symbol	Parameter	Value	Units
V_{CEO}	Collector-Emitter Voltage	60	V
V_{CBO}	Collector-Base Voltage	60	V
V_{EBO}	Emitter-Base Voltage	5.0	V
I_C	Collector Current - Continuous	1.2	A
T_J, T_{stg}	Operating and Storage Junction Temperature Range	-55 to +150	°C

*These ratings are limiting values above which the serviceability of any semiconductor device may be impaired.

NOTES:

- 1) These ratings are based on a maximum junction temperature of 150 degrees C.
- 2) These are steady state limits. The factory should be consulted on applications involving pulsed or low duty cycle operations.
- 3) All voltages (V) and currents (A) are negative polarity for PNP transistors.

Thermal Characteristics

TA = 25°C unless otherwise noted

Symbol	Characteristic	Max		Units
		TN6728A	*NZT6728	
P_D	Total Device Dissipation Derate above 25°C	1.0	1.0	W mW/°C
		8.0	8.0	
$R_{\theta JC}$	Thermal Resistance, Junction to Case	50		°C/W
$R_{\theta JA}$	Thermal Resistance, Junction to Ambient	125	125	°C/W

*Device mounted on FR-4 PCB 36 mm X 18 mm X 1.5 mm; mounting pad for the collector lead min. 6 cm².

PNP General Purpose Amplifier

(continued)

TN6728A / NZT6728

Electrical Characteristics TA = 25°C unless otherwise noted

Symbol	Parameter	Test Conditions	Min	Max	Units
OFF CHARACTERISTICS					
$V_{(BR)CEO}$	Collector-Emitter Breakdown Voltage	$I_C = 10 \text{ mA}, I_B = 0$	60		V
$V_{(BR)CBO}$	Collector-Base Breakdown Voltage	$I_C = 100 \text{ } \mu\text{A}, I_E = 0$	60		V
$V_{(BR)EBO}$	Emitter-Base Breakdown Voltage	$I_E = 1.0 \text{ mA}, I_C = 0$	5.0		V
I_{CBO}	Collector-Cutoff Current	$V_{CB} = 40 \text{ V}, I_E = 0$		0.1	μA
I_{EBO}	Emitter-Cutoff Current	$V_{EB} = 5.0 \text{ V}, I_C = 0$		0.1	μA

ON CHARACTERISTICS*

h_{FE}	DC Current Gain	$I_C = 50 \text{ mA}, V_{CE} = 1.0 \text{ V}$ $I_C = 250 \text{ mA}, V_{CE} = 1.0 \text{ V}$ $I_C = 500 \text{ mA}, V_{CE} = 1.0 \text{ V}$	80 50 20	250	
$V_{CE(sat)}$	Collector-Emitter Saturation Voltage	$I_C = 250 \text{ mA}, I_B = 10 \text{ mA}$ $I_C = 250 \text{ mA}, I_B = 25 \text{ mA}$		0.5 0.35	V
$V_{BE(on)}$	Base-Emitter On Voltage	$I_C = 250 \text{ mA}, V_{CE} = 1.0 \text{ V}$		1.2	V

SMALL SIGNAL CHARACTERISTICS

h_{fe}	Small-Signal Current Gain	$V_{CE} = 5.0 \text{ V}, I_C = 200 \text{ mA},$ $f = 20 \text{ MHz}$	2.5	25	
C_{cb}	Collector-Base Capacitance	$V_{CB} = 10 \text{ V}, I_E = 0, f = 1.0 \text{ MHz}$		30	pF

*Pulse Test: Pulse Width $\leq 300 \text{ } \mu\text{s}$, Duty Cycle $\leq 1.0\%$

NOTE: All voltages (V) and currents (A) are negative polarity for PNP transistors.

Typical Characteristics

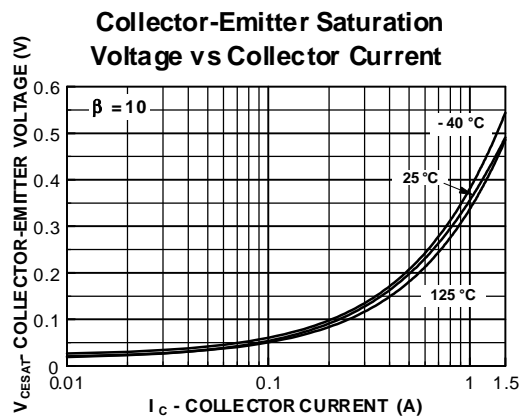
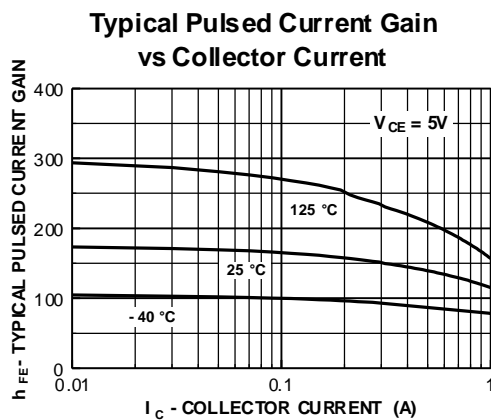

PNP General Purpose Amplifier

(continued)

TN6728A / NZT6728

Typical Characteristics (continued)

Base-Emitter Saturation Voltage vs Collector Current

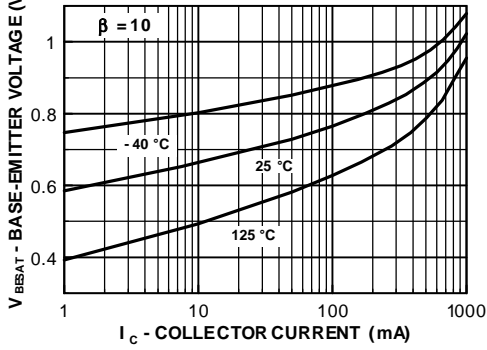

Base-Emitter ON Voltage vs Collector Current

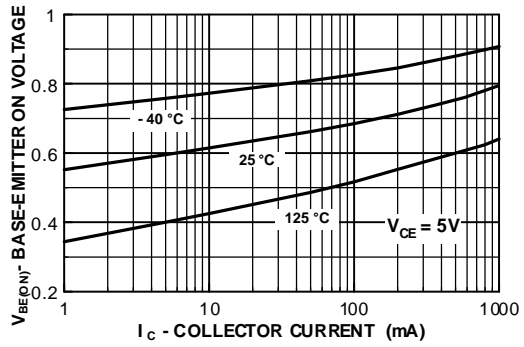

Collector-Cutoff Current vs Ambient Temperature

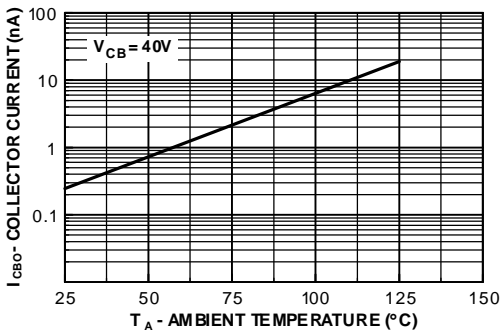

Collector-Base Capacitance vs Collector-Base Voltage

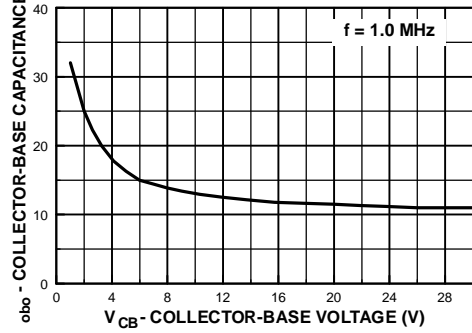

Gain Bandwidth Product vs Collector Current

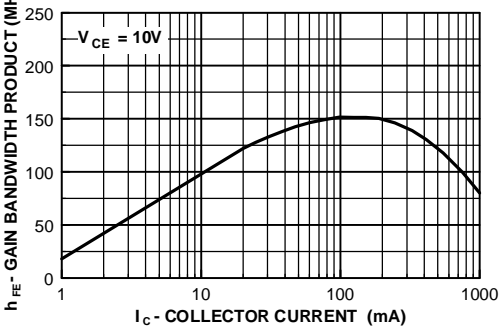

Safe Operating Area TO-226 / SOT-223

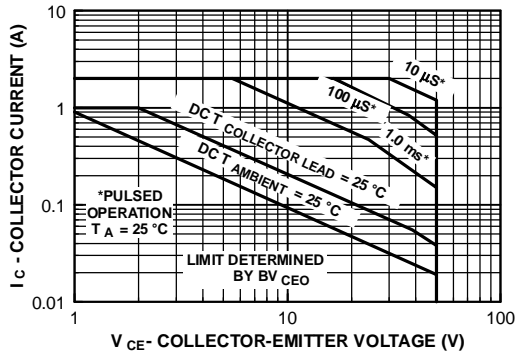

Typical Characteristics (continued)

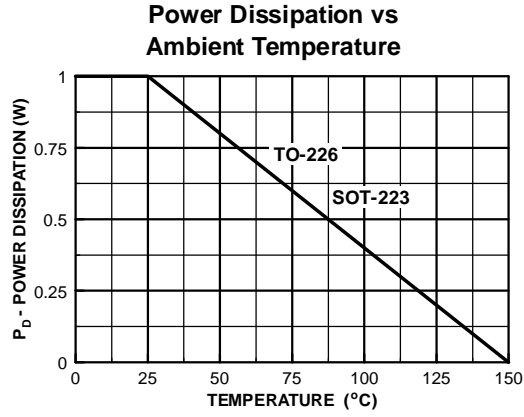

TO-226AE Tape and Reel Data



TO-226AE Packaging Configuration: Figure 1.0

FSCINT Label sample

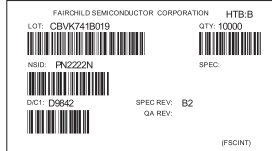

F63TNR Label sample



TO-226AE TNR/AMMO PACKING INFORMATION

Packing	Style	Quantity	EOL code
Reel	A	2,000	D26Z
	E	2,000	D27Z
Ammo	M	2,000	D74Z
	P	2,000	D75Z

Unit weight = 0.300gm
 Reel weight with components = 0.868 kg
 Ammo weight with components = 0.880 kg
 Max quantity per intermediate box = 10,000 units

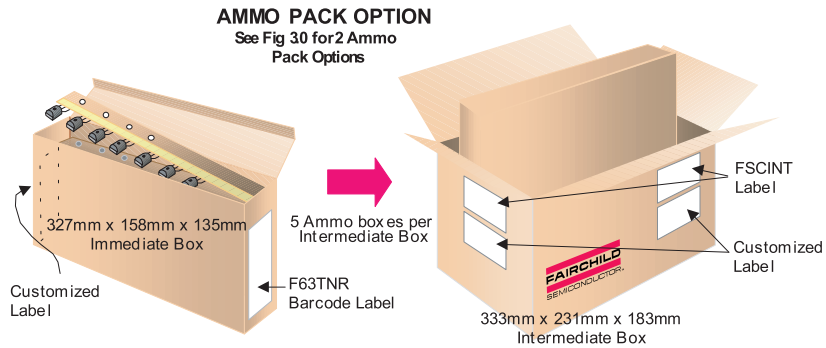

BULK OPTION

See Bulk Packing Information table

(TO-226AE) BULK PACKING INFORMATION

EOL CODE	DESCRIPTION	LEADCLIP DIMENSION	QUANTITY
J18Z	TO-18 OPTION STD	NO LEAD CLIP	1.0 K / BOX
J05Z	TO-5 OPTION STD	NO LEAD CLIP	1.0 K / BOX
NO EOL CODE	TO-226 STANDARD STRAIGHT	NO LEADCLIP	1.5 K / BOX

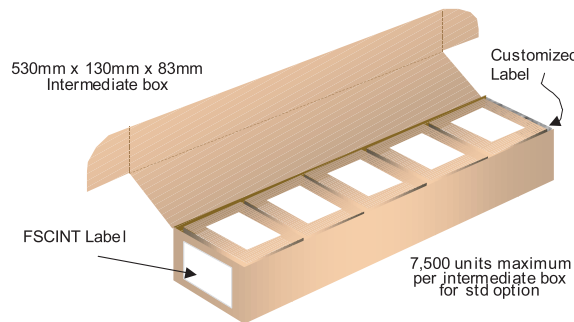
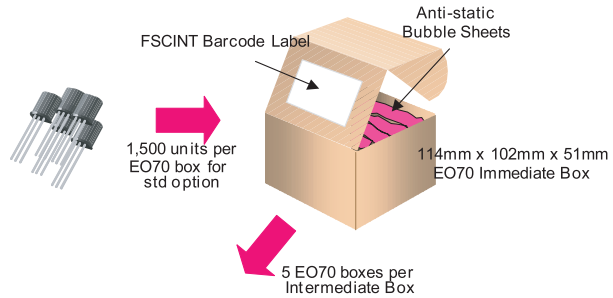

TO-226AE Tape and Reel Data, continued

TO-226AE Reeling Style Configuration: Figure 2.0

Machine Option "A"(H)

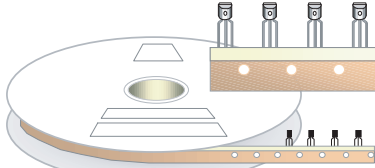

Style "A" D26Z, D70Z (s/h)

Machine Option "E"(J)

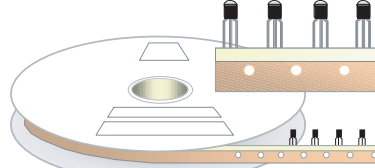

Style "E" D27Z, D71Z (s/h)

TO-226AE Radial Ammo Packaging Configuration: Figure 3.0

FIRST WIRE OFF IS COLLECTOR (ON PKG. 92)
ADHESIVE TAPE IS ON THE TOP SIDE
FLAT OF TRANSISTOR IS ON TOP

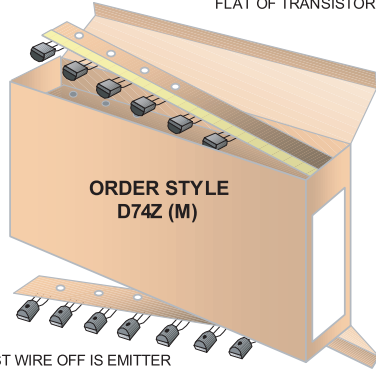

ORDER STYLE
D74Z (M)

FIRST WIRE OFF IS EMITTER
ADHESIVE TAPE IS ON BOTTOM SIDE
FLAT OF TRANSISTOR IS ON BOTTOM

FIRST WIRE OFF IS EMITTER (ON PKG. 92)
ADHESIVE TAPE IS ON THE TOP SIDE
FLAT OF TRANSISTOR IS ON BOTTOM



ORDER STYLE
D75Z (P)

FIRST WIRE OFF IS COLLECTOR
ADHESIVE TAPE IS ON BOTTOM SIDE
FLAT OF TRANSISTOR IS ON TOP

TO-226AE Tape and Reel Data, continued

**TO-226AE Tape and Reel Taping
Dimension Configuration:** Figure 4.0



ITEM DESCRIPTION	SYMBOL	DIMENSION
Base of Package to Lead Bend	b	0.098 (max)
Component Height	Hb	1.078 (+/- 0.050)
Lead Clinch Height	HO	0.630 (+/- 0.020)
Component Base Height	H1	0.748 (+/- 0.020)
Component Alignment (side/side)	Pd	0.040 (max)
Component Alignment (front/back)	Hd	0.031 (max)
Component Pitch	P	0.500 (+/- 0.020)
Feed Hole Pitch	PO	0.500 (+/- 0.008)
Hole Center to First Lead	P1	0.150 (+0.009, -0.010)
Hole Center to Component Center	P2	0.247 (+/- 0.007)
Lead Spread	F1/F2	0.104 (+/- 0.010)
Lead Thickness	d	0.018 (+0.002, -0.003)
Out Lead Length	L	0.429 (max)
Taped Lead Length	L1	0.209 (+0.051, -0.052)
Taped Lead Thickness	t	0.032 (+/- 0.006)
Carrier Tape Thickness	t1	0.021 (+/- 0.006)
Carrier Tape Width	W	0.708 (+0.02, -0.019)
Hold - down Tape Width	W0	0.236 (+/- 0.012)
Hold - down Tape position	W1	0.035 (max)
Feed Hole Position	W2	0.360 (+/- 0.025)
Sprocket Hole Diameter	DO	0.157 (+0.008, -0.007)
Lead Spring Out	S	0.004 (max)

Note: All dimensions are in inches.

**TO-226AE Reel
Configuration:** Figure 5.0



ITEM DESCRIPTION	SYMBOL	MINIMUM	MAXIMUM
Reel Diameter	D1	1.3975	14.025
Arbor Hole Diameter (Standard)	D2	1.160	1.200
(Small Hole)	D2	0.650	0.700
Core Diameter	D3	3.100	3.300
Hub Recess Inner Diameter	D4	2.700	3.100
Hub Recess Depth	W1	0.370	0.570
Flange to Flange Inner Width	W2	1.630	1.690
Hub to Hub Center Width	W3		2.090

Note: All dimensions are in inches

TO-226AE Package Dimensions



TO-226AE (FS PKG Code 95, 99)

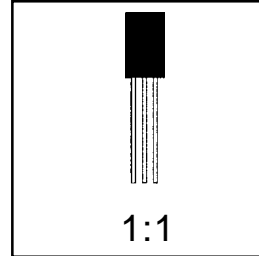

Scale 1:1 on letter size paper

Dimensions shown below are in:
inches [millimeters]

Part Weight per unit (gram): 0.300

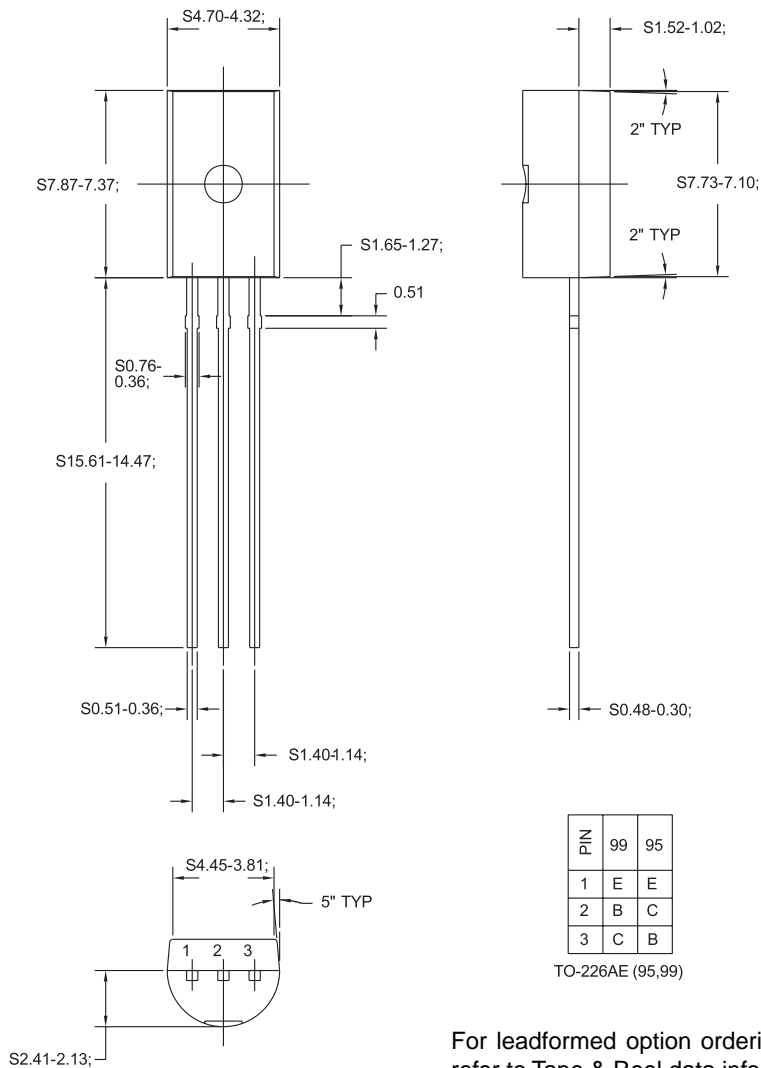

DIN	99	95
1	E	E
2	B	C
3	C	B

TO-226AE (95,99)

For leadformed option ordering,
refer to Tape & Reel data information.

SOT-223 Tape and Reel Data



SOT-223 Packaging Configuration: Figure 1.0

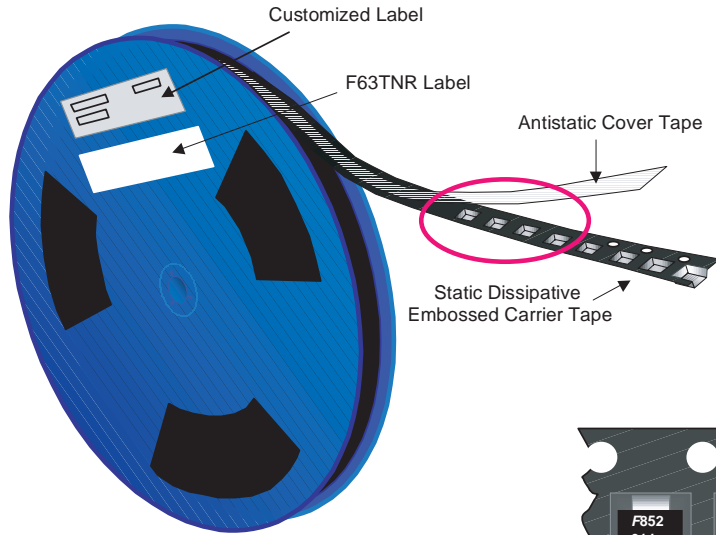

Packaging Description:
 SOT-223 parts are shipped in tape. The carrier tape is made from a dissipative (carbon filled) polycarbonate resin. The cover tape is a multilayer film (Heat Activated Adhesive in nature) primarily composed of polyester film, adhesive layer, sealant, and anti-static sprayed agent. These reeled parts in standard option are shipped with 2,500 units per 13" or 330cm diameter reel. The reels are dark blue in color and is made of polystyrene plastic (anti-static coated). Other option comes in 500 units per 7" or 177cm diameter reel. This and some other options are further described in the Packaging Information table.
 These full reels are individually barcode labeled and placed inside a standard intermediate box (illustrated in figure 1.0) made of recyclable corrugated brown paper. One box contains two reels maximum. And these boxes are placed inside a barcode labeled shipping box which comes in different sizes depending on the number of parts shipped.

SOT-223 Packaging Information		
Packaging Option	Standard (no flow code)	D84Z
Packaging type	TNR	TNR
Qty per Reel/Tube/Bag	2,500	500
Reel Size	13" Dia	7" Dia
Box Dimension (mm)	343x64x343	184x187x47
Max qty per Box	5,000	1,000
Weight per unit (gm)	0.1246	0.1246
Weight per Reel (kg)	0.7250	0.1532
Note/Comments		

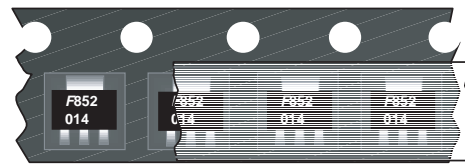

SOT-223 Unit Orientation

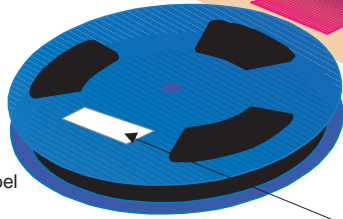

F63TNR Label sample

LOT: CBVK741B019	QTY: 3000
FSID: PN2222A	SPEC:
D/C1: D9842	QTY1:
D/C2:	QTY2:
SPEC REV: CPN:	N/F: F
(F63TNR)3	

SOT-223 Tape Leader and Trailer Configuration: Figure 2.0

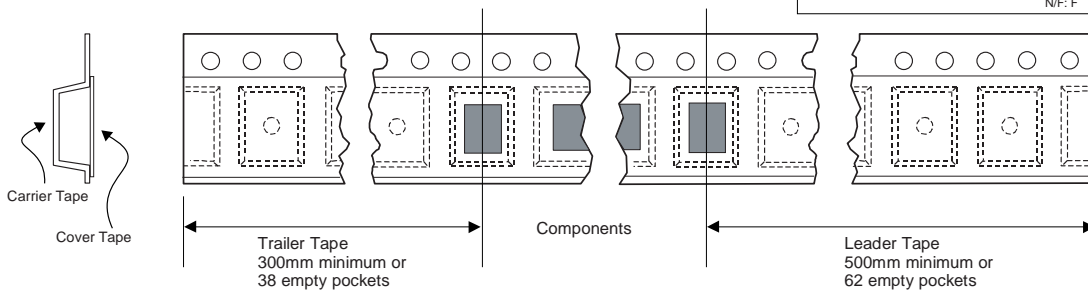

SOT-223 Tape and Reel Data, continued

SOT-223 Embossed Carrier Tape Configuration: Figure 3.0



Dimensions are in millimeter														
Pkg type	A0	B0	W	D0	D1	E1	E2	F	P1	P0	K0	T	Wc	Tc
SOT-223 (12mm)	6.83 +/-0.10	7.42 +/-0.10	12.0 +/-0.3	1.55 +/-0.05	1.50 +/-0.10	1.75 +/-0.10	10.25 min	5.50 +/-0.05	8.0 +/-0.1	4.0 +/-0.1	1.88 +/-0.10	0.292 +/- 0.0130	9.5 +/-0.025	0.06 +/-0.02

Notes: A0, B0, and K0 dimensions are determined with respect to the EIA/Jedec RS-481 rotational and lateral movement requirements (see sketches A, B, and C).

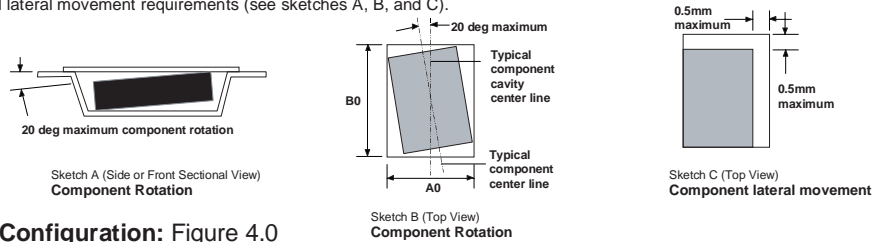

SOT-223 Reel Configuration: Figure 4.0



Dimensions are in inches and millimeters									
Tape Size	Reel Option	Dim A	Dim B	Dim C	Dim D	Dim N	Dim W1	Dim W2	Dim W3 (LSL-USL)
12mm	7" Dia	7.00 177.8	0.059 1.5	512 +0.020/-0.008 13 +0.5/-0.2	0.795 20.2	5.906 150	0.488 +0.078/-0.000 12.4 +2/0	0.724 18.4	0.469 - 0.606 11.9 - 15.4
12mm	13" Dia	13.00 330	0.059 1.5	512 +0.020/-0.008 13 +0.5/-0.2	0.795 20.2	7.00 178	0.488 +0.078/-0.000 12.4 +2/0	0.724 18.4	0.469 - 0.606 11.9 - 15.4

SOT-223 Package Dimensions



SOT-223 (FS PKG Code 47)

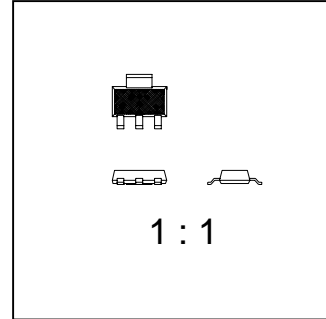
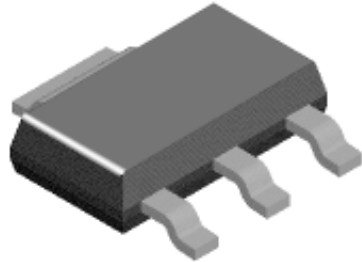

Scale 1:1 on letter size paper

Part Weight per unit (gram): 0.1246

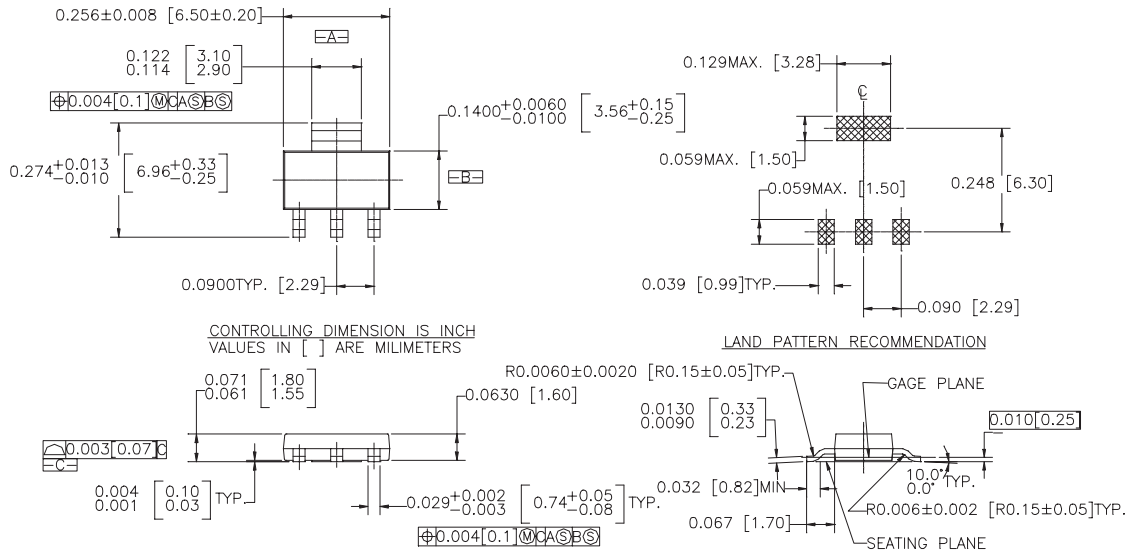

- NOTES : UNLESS OTHERWISE SPECIFIED
- STANDARD LEAD FINISH TO BE 150 MICRONS/ 3.81 MICROMETERS MINIMUM TIN/LEAD (SOLDER) ON COPPER.
 - REFERENCE JEDEC REGISTRATION TO-261, VARIATION AA, ISSUE A, DATED JAN 1990

TRADEMARKS

The following are registered and unregistered trademarks Fairchild Semiconductor owns or is authorized to use and is not intended to be an exhaustive list of all such trademarks.

ACEx™	FASTr™	PowerTrench®	SyncFET™
Bottomless™	GlobalOptoisolator™	QFET™	TinyLogic™
CoolFET™	GTO™	QS™	UHC™
CROSSVOLT™	HiSeC™	QT Optoelectronics™	VCX™
DOME™	ISOPANAR™	Quiet Series™	
E ² CMOS™	MICROWIRE™	SILENT SWITCHER®	
EnSigna™	OPTOLOGIC™	SMART START™	
FACT™	OPTOPLANAR™	SuperSOT™-3	
FACT Quiet Series™	PACMAN™	SuperSOT™-6	
FAST®	POP™	SuperSOT™-8	

DISCLAIMER

FAIRCHILD SEMICONDUCTOR RESERVES THE RIGHT TO MAKE CHANGES WITHOUT FURTHER NOTICE TO ANY PRODUCTS HEREIN TO IMPROVE RELIABILITY, FUNCTION OR DESIGN. FAIRCHILD DOES NOT ASSUME ANY LIABILITY ARISING OUT OF THE APPLICATION OR USE OF ANY PRODUCT OR CIRCUIT DESCRIBED HEREIN; NEITHER DOES IT CONVEY ANY LICENSE UNDER ITS PATENT RIGHTS, NOR THE RIGHTS OF OTHERS.

LIFE SUPPORT POLICY

FAIRCHILD'S PRODUCTS ARE NOT AUTHORIZED FOR USE AS CRITICAL COMPONENTS IN LIFE SUPPORT DEVICES OR SYSTEMS WITHOUT THE EXPRESS WRITTEN APPROVAL OF FAIRCHILD SEMICONDUCTOR CORPORATION. As used herein:

1. Life support devices or systems are devices or systems which, (a) are intended for surgical implant into the body, or (b) support or sustain life, or (c) whose failure to perform when properly used in accordance with instructions for use provided in the labeling, can be reasonably expected to result in significant injury to the user.
2. A critical component is any component of a life support device or system whose failure to perform can be reasonably expected to cause the failure of the life support device or system, or to affect its safety or effectiveness.

PRODUCT STATUS DEFINITIONS

Definition of Terms

Datasheet Identification	Product Status	Definition
Advance Information	Formative or In Design	This datasheet contains the design specifications for product development. Specifications may change in any manner without notice.
Preliminary	First Production	This datasheet contains preliminary data, and supplementary data will be published at a later date. Fairchild Semiconductor reserves the right to make changes at any time without notice in order to improve design.
No Identification Needed	Full Production	This datasheet contains final specifications. Fairchild Semiconductor reserves the right to make changes at any time without notice in order to improve design.
Obsolete	Not In Production	This datasheet contains specifications on a product that has been discontinued by Fairchild semiconductor. The datasheet is printed for reference information only.